

KATALOG FEFCO

Cílem katalogu je zjednodušení rozlišení druhů konstrukcí kartonážních výrobků pomocí jednoduchých mezinárodních symbolů.

D - délka

Š - šířka

V - výška

/v - přesah odnímatelného víka nebo dna

/o - přesah klop přes sebe

Pro měření a uvádění rozměrů obalů platí tato pravidla: rozměry se uvádějí v mm rozměry se uvádějí v pořadí DxŠxV, nebo DxŠxV/v, nebo DxŠxV/o uvádějí se vnitřní rozměry obalů, měřené za standardních klimatických podmínek na rozloženém obalu

Např.: FEFCO 0202 315x235x185/40 mm- klopová krabice s přesahem klop 40 mm přes sebe

Kódy konstrukcí obalů a rozdělení do konstrukčních skupin :

Číselné kódy základních konstrukcí obalů jsou vždy 4 místné a začínají nulou.

V řadě případů základní kódy nepostačují k označení konstrukce obalu. Pak lze kombinovat různé typy kódů. Označení v takovém případě zahrnuje obě nebo všechny použité standardní konstrukce, které se udávají v pořadí shora.

Příklady:

FEFCO 0713/0715, tj. horní uzávěr jako 0713, dno jako 0715

FEFCO 0215/0216, tj. víko jako 0215, dno jako 0216

Význam čísla na 2. pozici:

2 - klopové krabice, většinou z jednoho, někdy (přesahuje-li délka přířezu pracovní šířku výrobní linky) ze dvou přířezů, lepené nebo šité, opatřené klopami nahoře i dole. Dodávají se rozložené.

3 - dvou nebo více dílné obaly (většinou spodek - víko, nebo dno - tělo - víko), lepené, šité nebo samosvorné, uzavírají se nasunutím víka, nebo dna a víka na spodek nebo tělo obalu.

4 - převážně nelepené, nesešíváné obaly (často označované jako tvarové výseky). Jsou tvořeny převážně jedním přířezem a uzavírají se zejména pomocí různě konstrukčně řešených zámků. Součástí konstrukce obalu mohou být např. otvory pro jeho snadné uchopení, odtrhovací okénka apod.

5 - obaly ze dvou nebo více dílů, které se zasouvají do sebe. Tato skupina obsahuje i přebaly pro jiné typy konstrukcí.

6 - obaly sestávající ze dvou bočnic a těla. Před použitím vyžadují sešítí.

7 - vícebodově (3x až 6x) lepené skládací obaly, vyrobené většinou z jednoho přířezu, dodávají se rozložené a lze je snadno složit.

9 - vnitřní vybavení obalů

Protože vývoj obalů neustále pokračuje, tento katalog samozřejmě nemůže postihnout vyčerpávajícím způsobem všechny možnosti konstrukce obalů z vlnitých lepenek. Specifické potřeby zákazníků je proto možno řešit vývojem individuálních konstrukcí obalů, obsahujících nestandardní prvky.

Protože vývoj obalů neustále pokračuje, tento katalog samozřejmě nemůže postihnout vyčerpávajícím způsobem všechny možnosti konstrukce obalů z vlnitých lepenek. Specifické potřeby zákazníků je proto možno řešit vývojem individuálních konstrukcí obalů, obsahujících nestandardní prvky.

KLOPOVÉ KRABICE :

0200

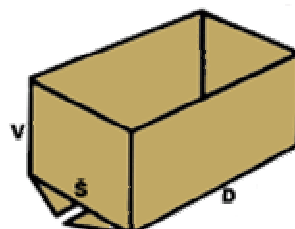

0201

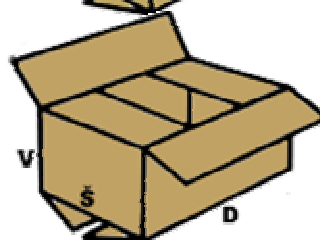

0202

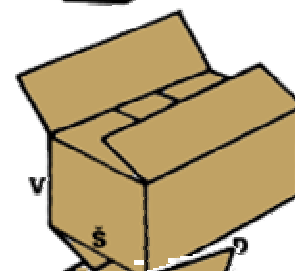
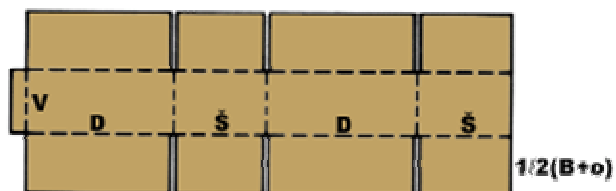

0203

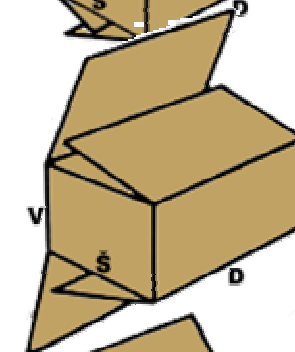
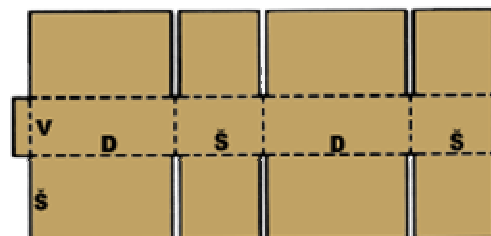

0205

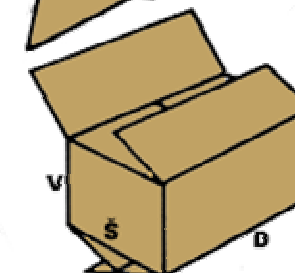
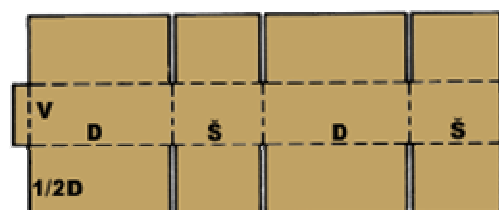

0208

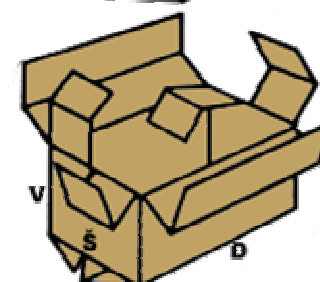
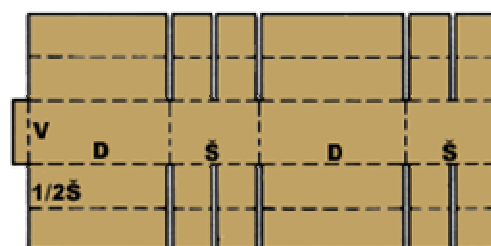

0209

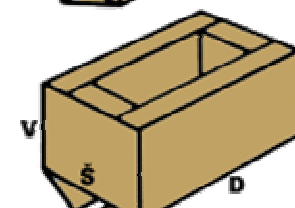

0214

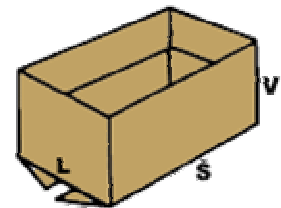
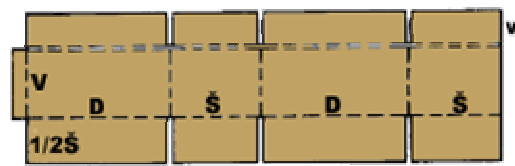

0230

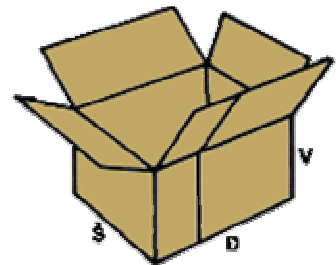
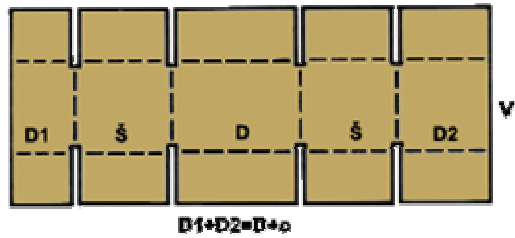

VÍKOVÉ KRABICE :

0300

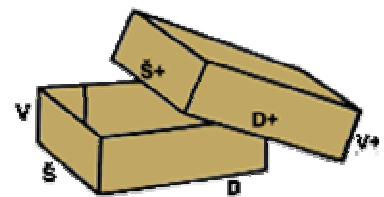
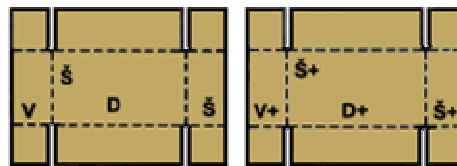

0301

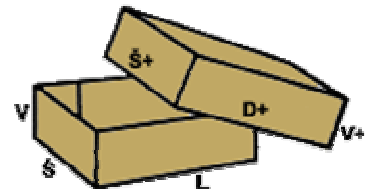
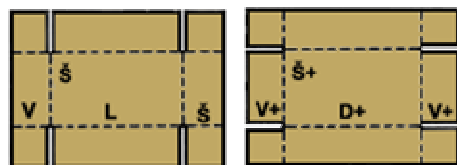

0302

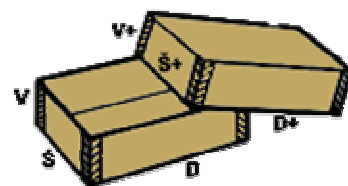
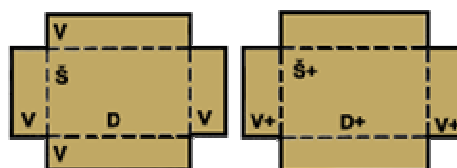

0303

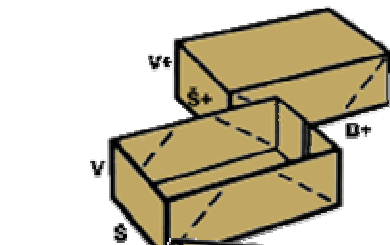
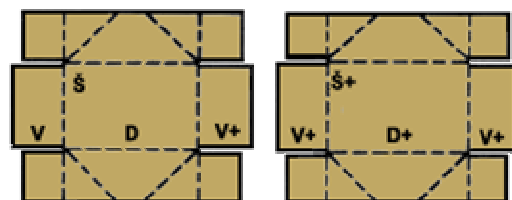

0304

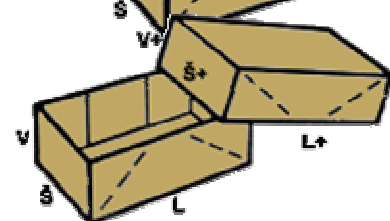
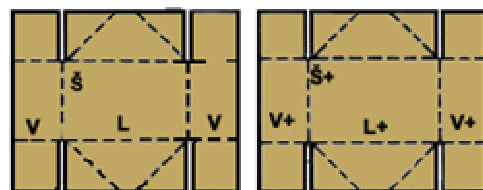

0305

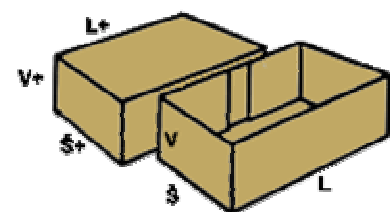
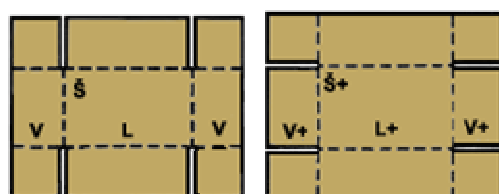

0306

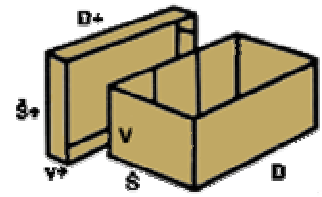
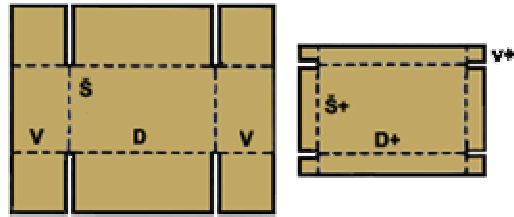

0307

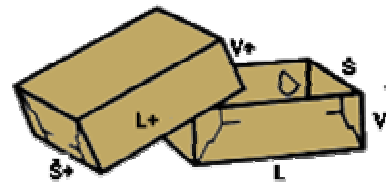
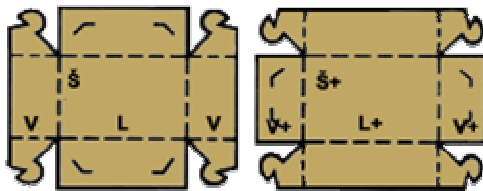

0308

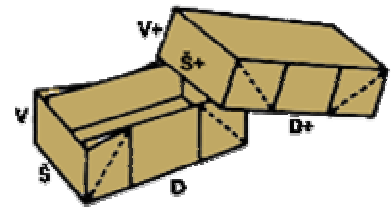
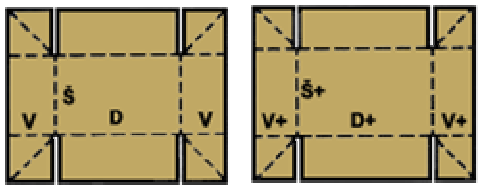

0309

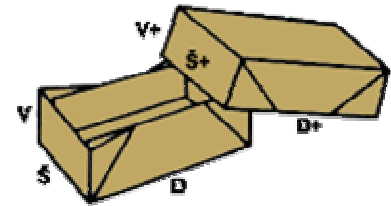
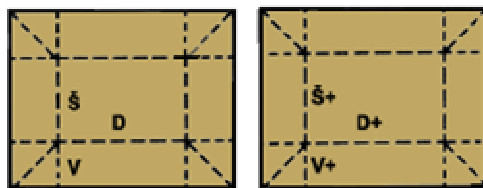

0310

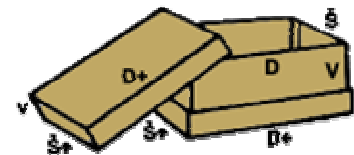
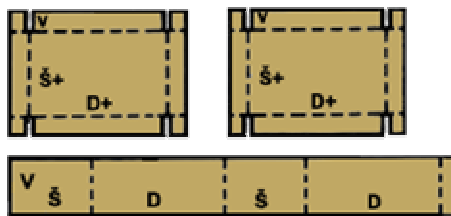

0311

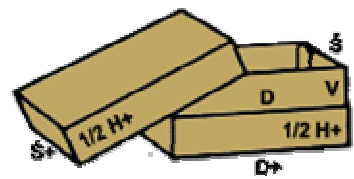
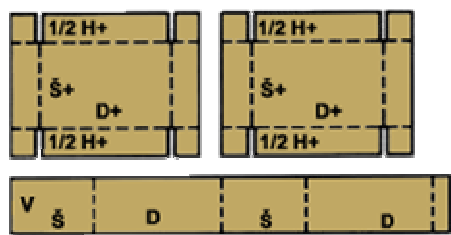

0312

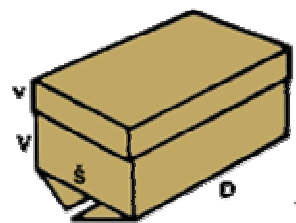
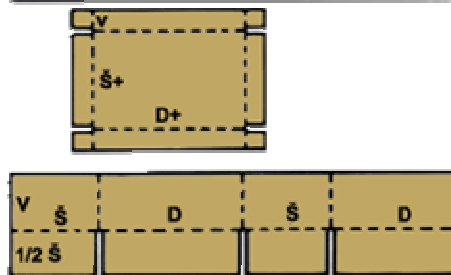

0313

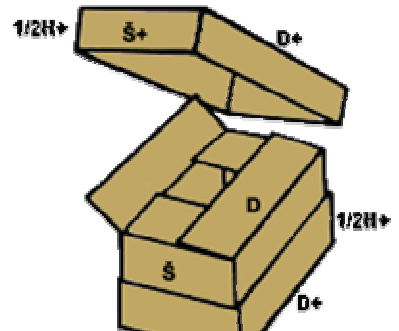
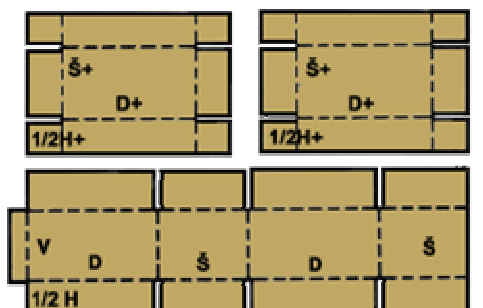

0314

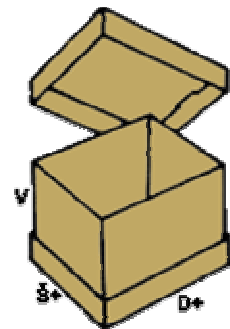
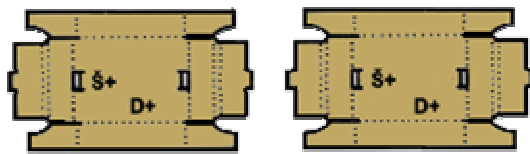

0320

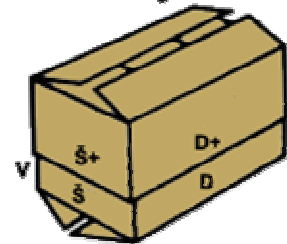
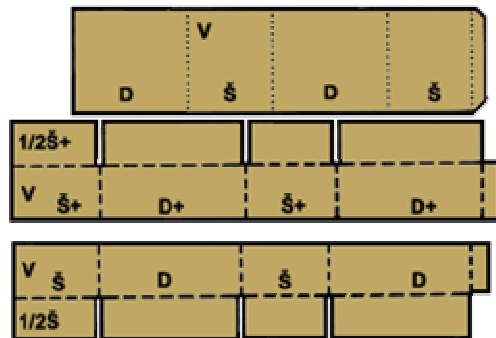

0321

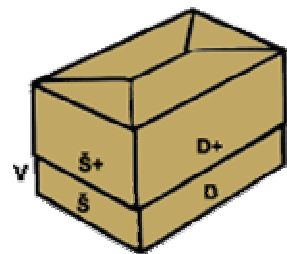
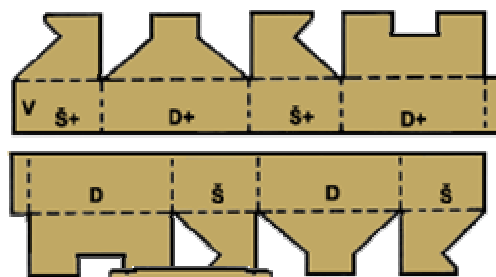

0322

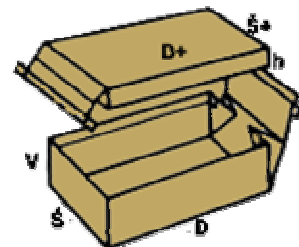
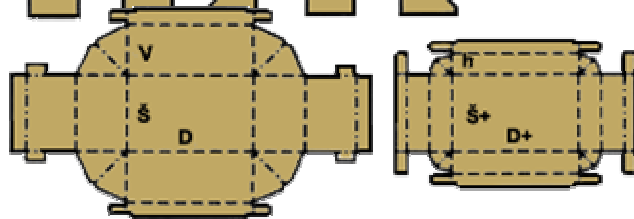

0323

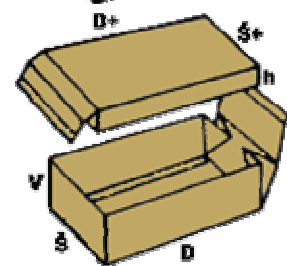
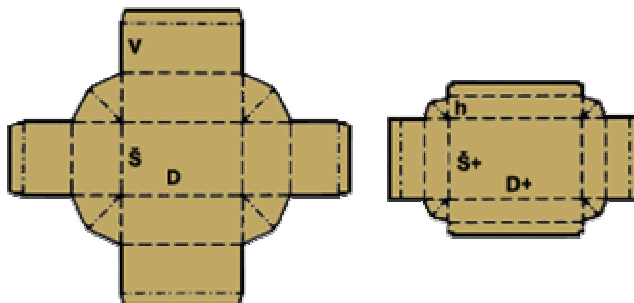

0325

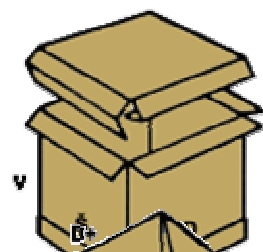
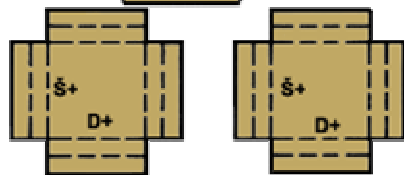

0330

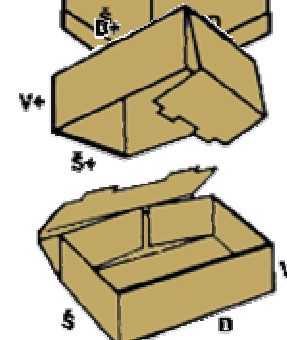
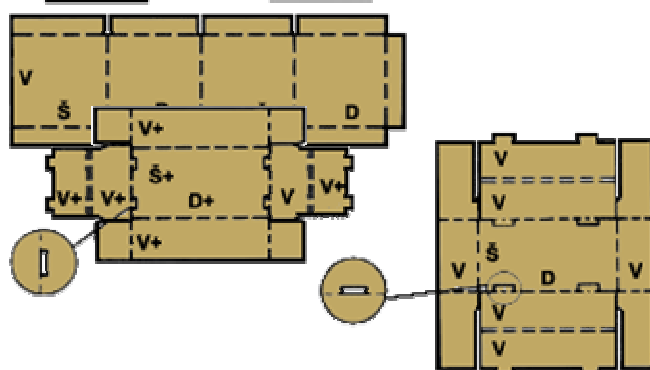

0331



0350

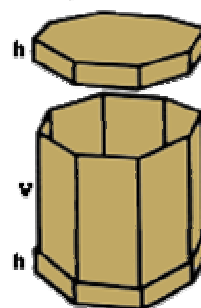
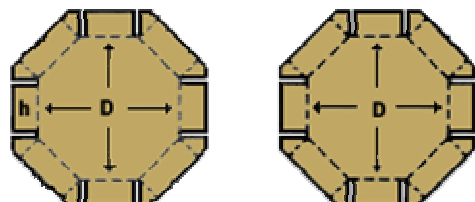
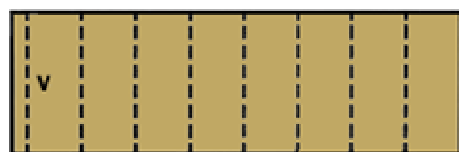

0351

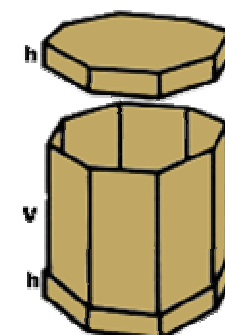
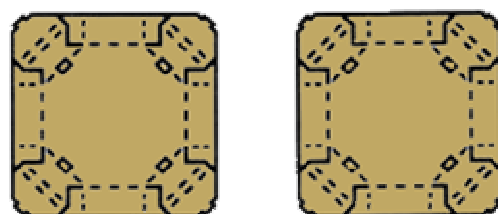
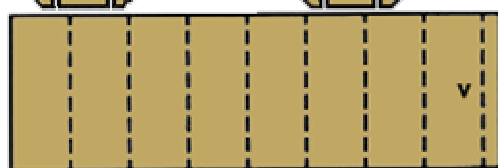

TVAROVÉ VÝSEKY :

0204

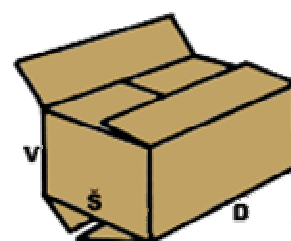
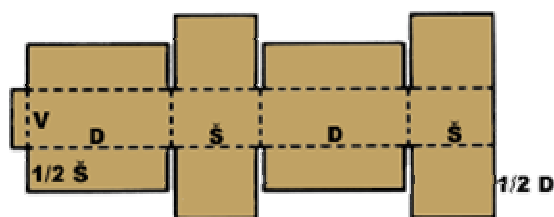

0206

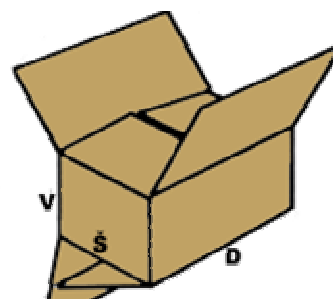
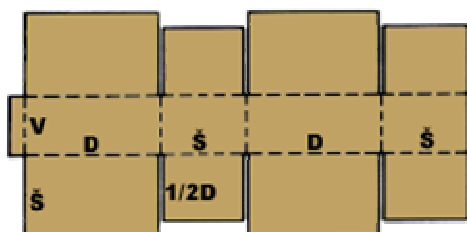

0207

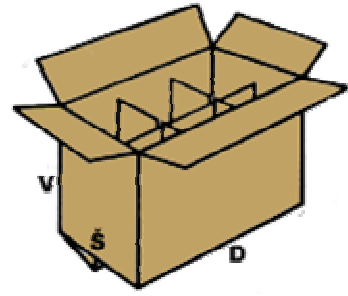
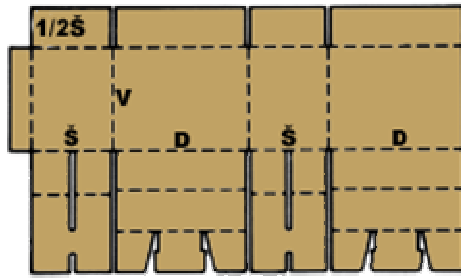

0210

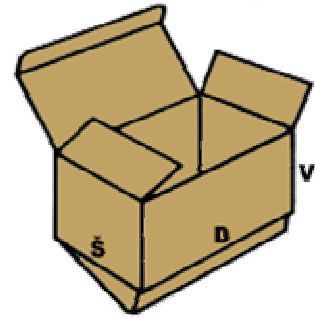
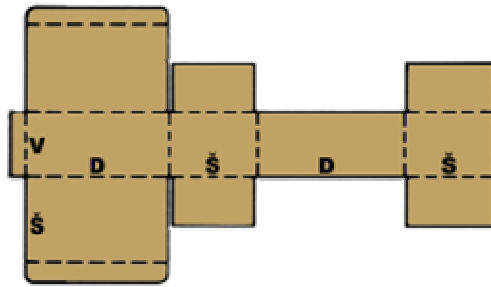

0211

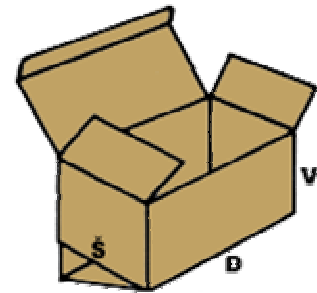
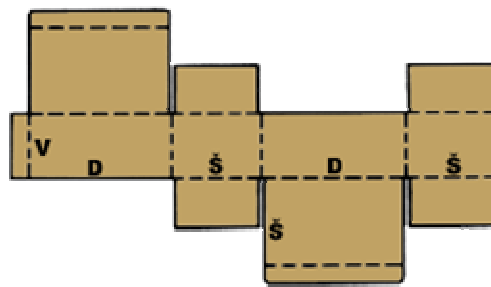

0212

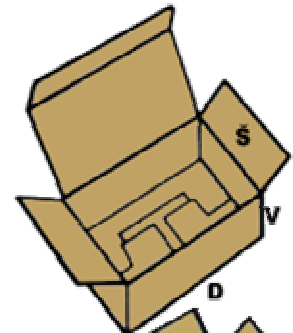
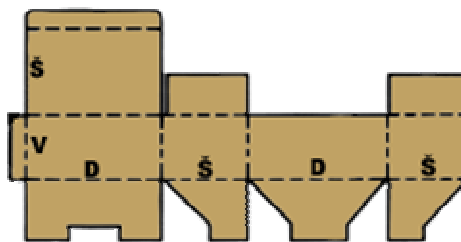

0215

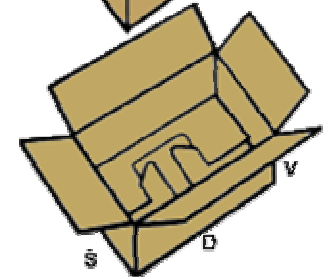
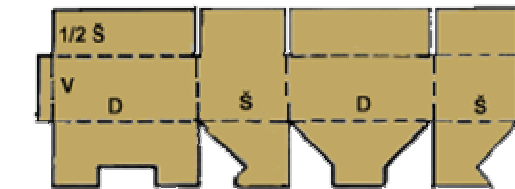

0216

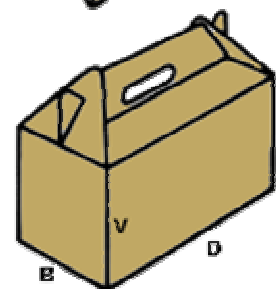
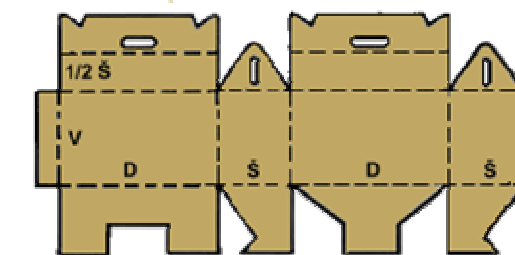

0217

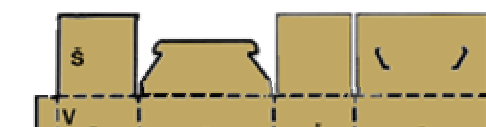

0218

0225

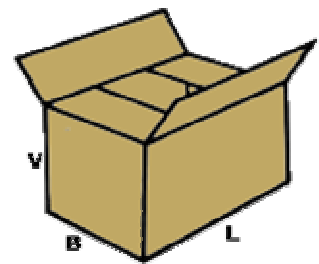
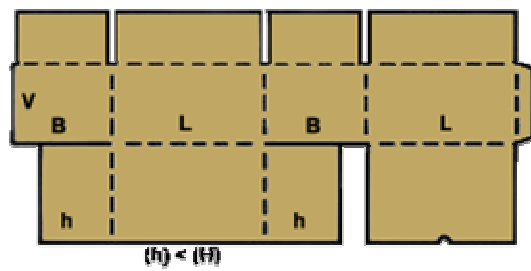

0226

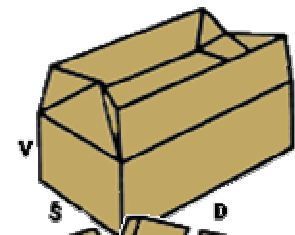
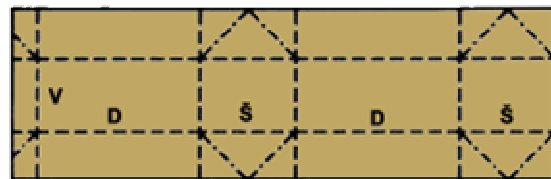

0227

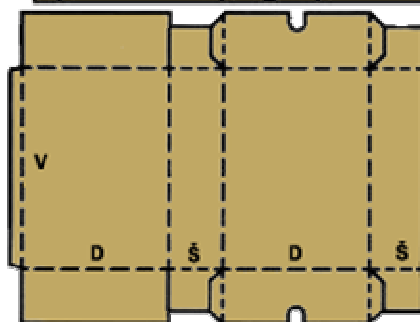

0228

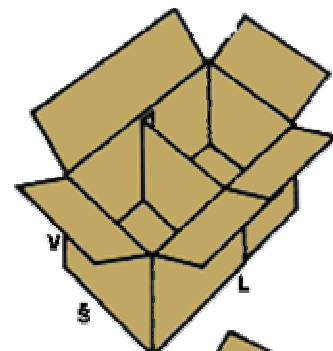
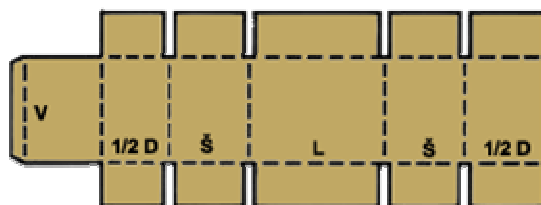

0229

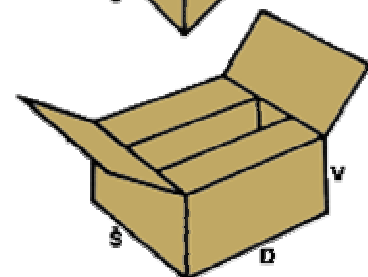
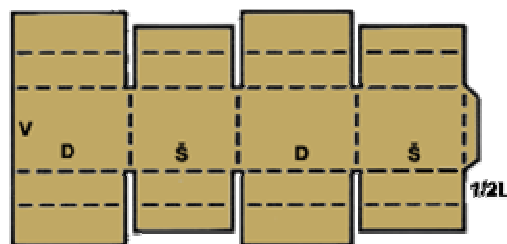

0401

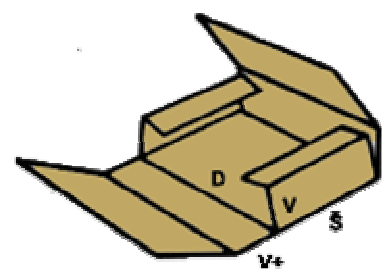
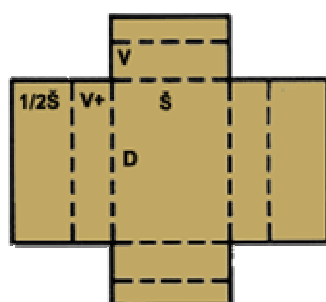

0402



0403

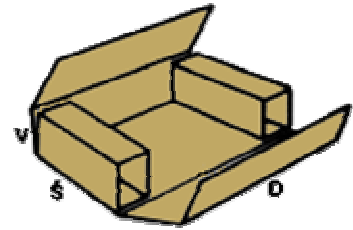
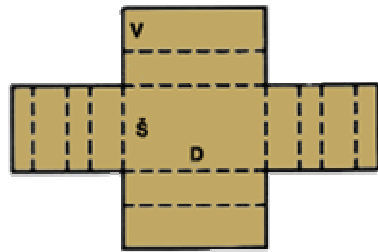

0404

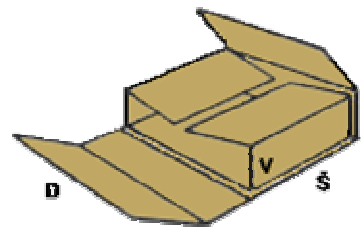
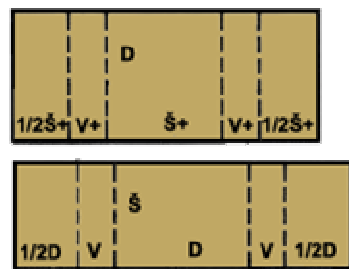

0405

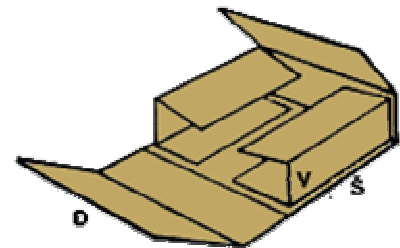
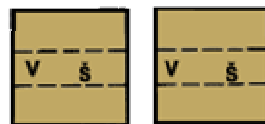

0406

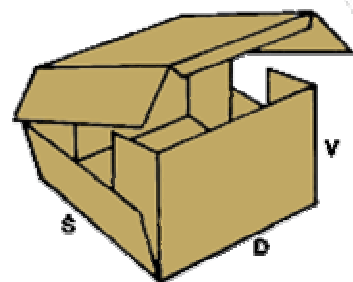
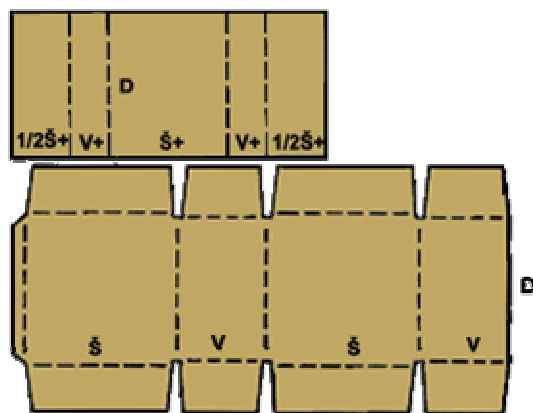

0409

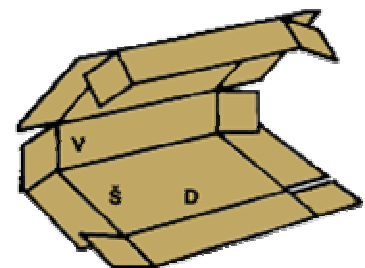
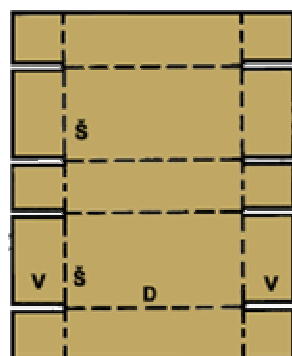

0410

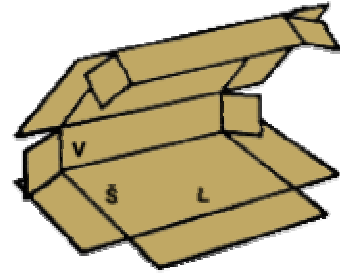
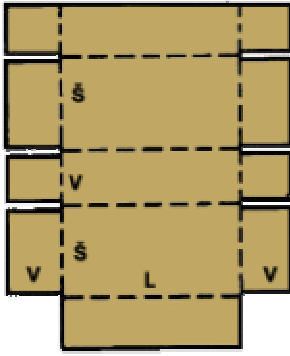

0411

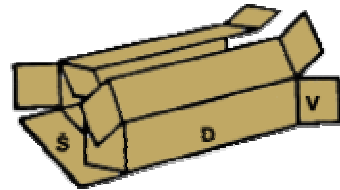
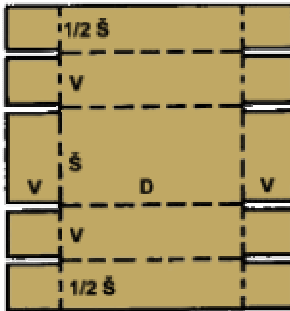

0412

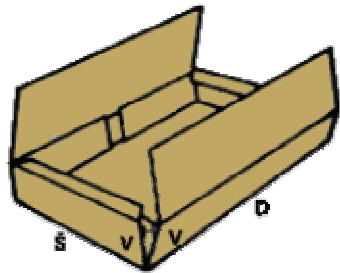
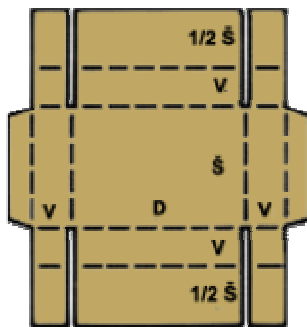

0415

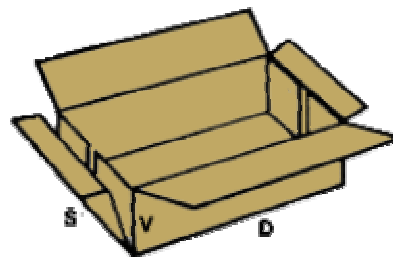
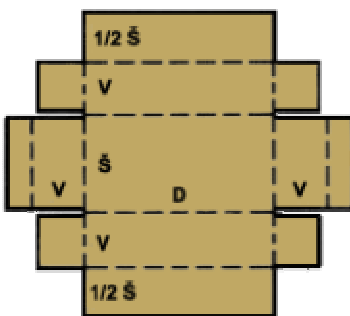

0416

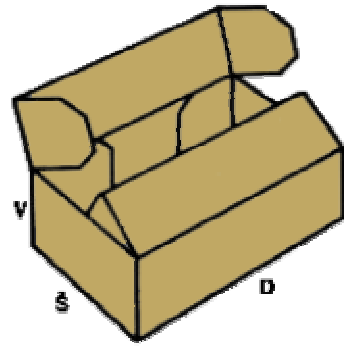
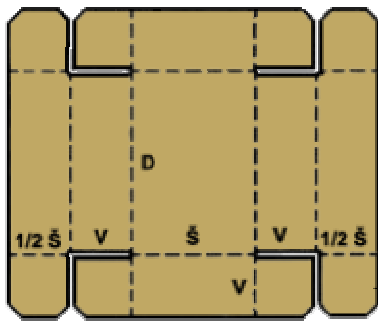

0420

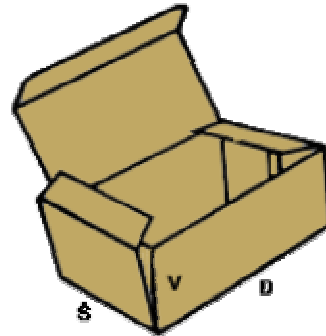
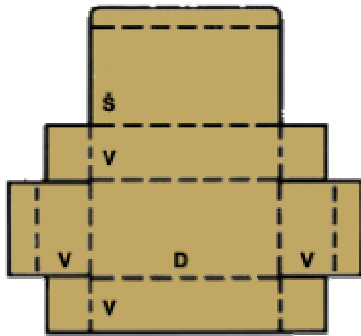

0421

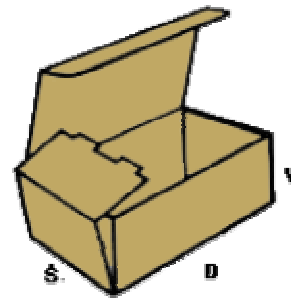
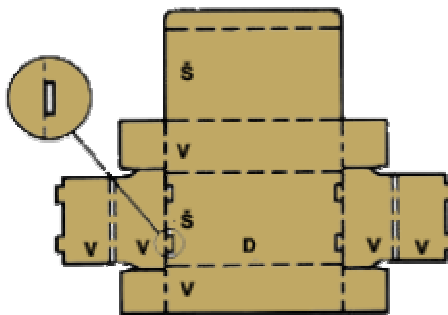

0422

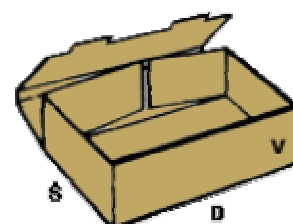
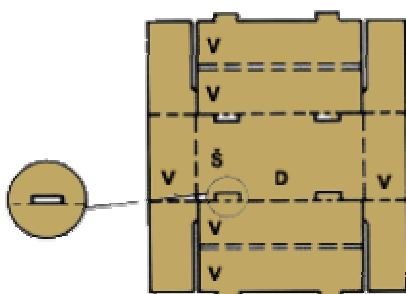
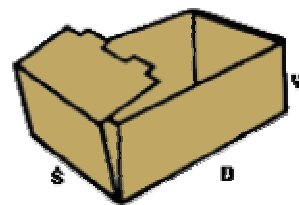
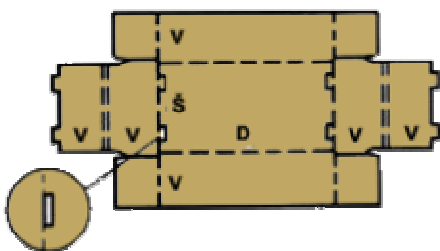

0424

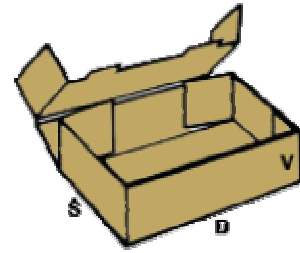
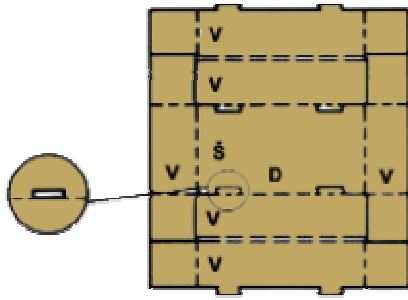

0425

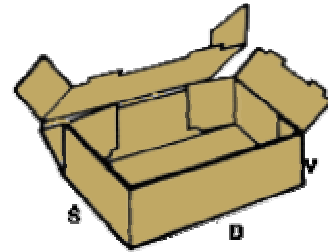
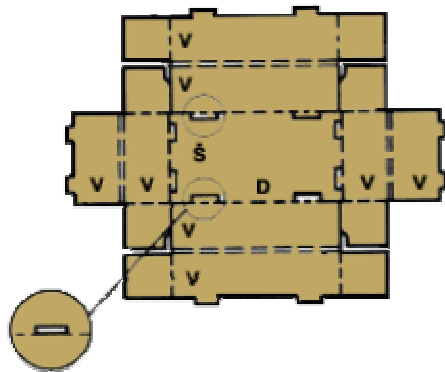

0426

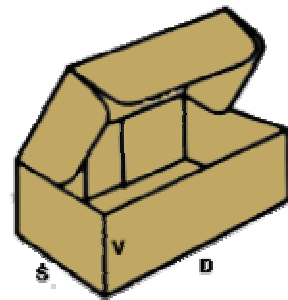
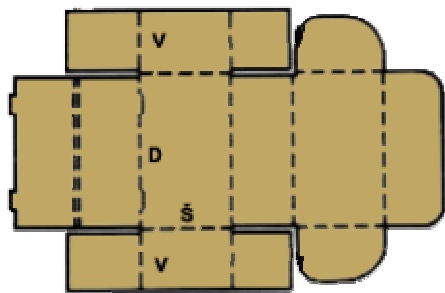

0427

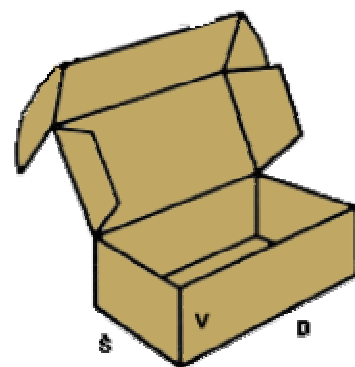
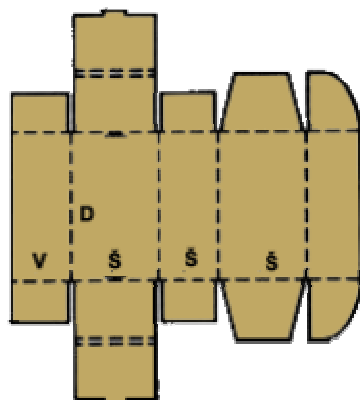

0428

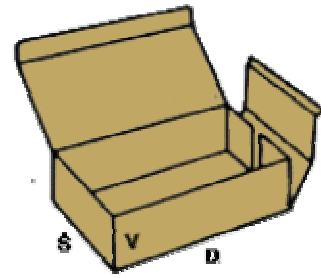
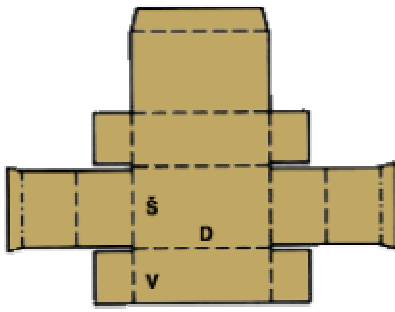

0429

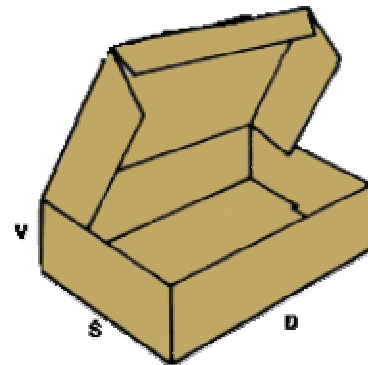
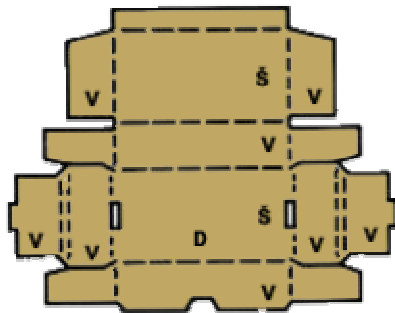

0430

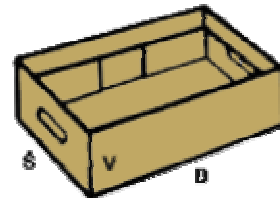
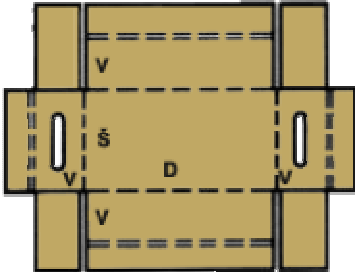

0431

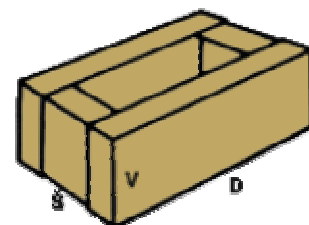
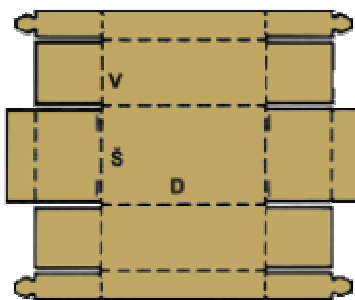

0432

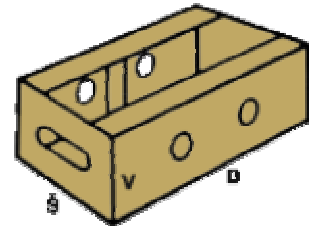
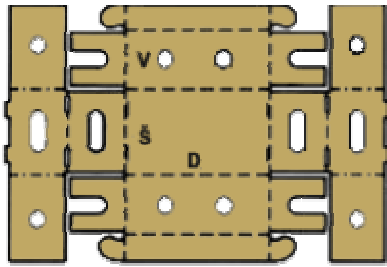

0433

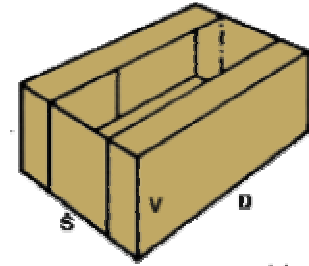
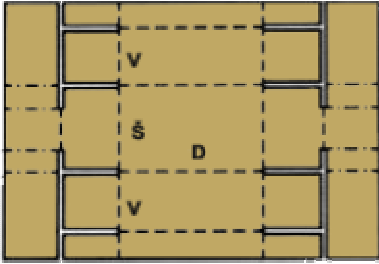

0434

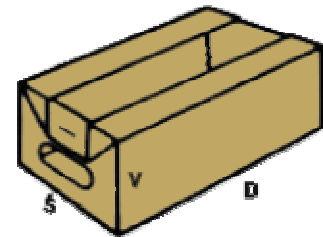
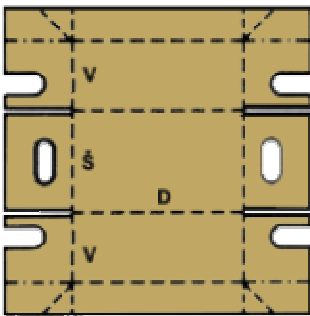

0435

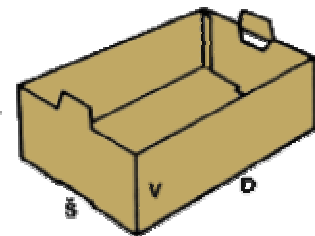
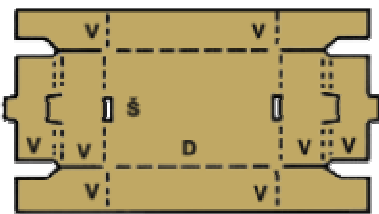

0436

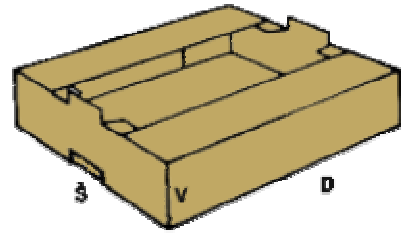
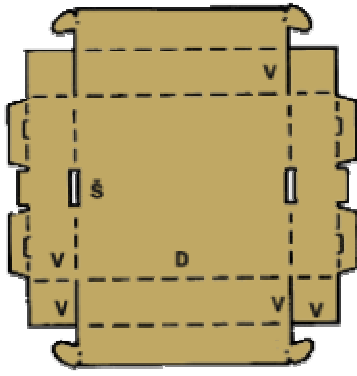

0437

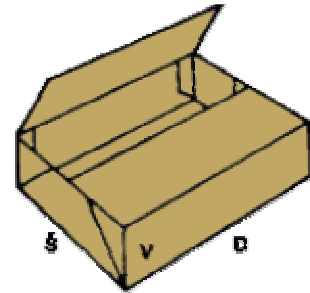
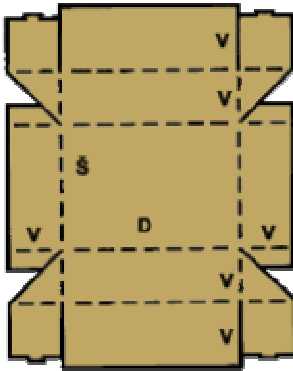

0440

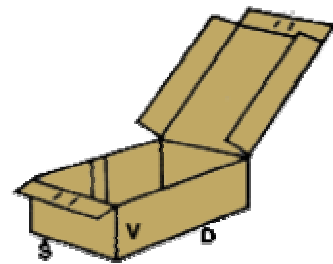
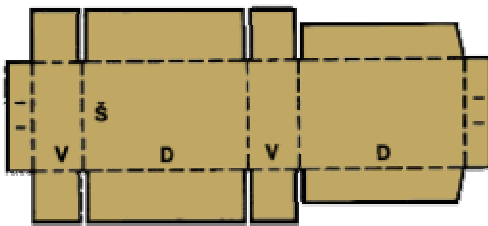

0441

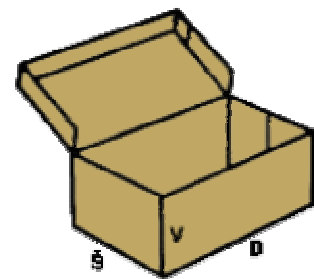
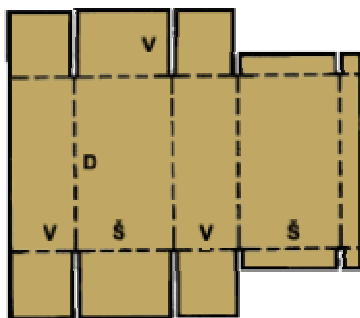

0442

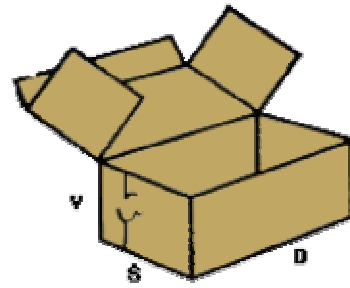
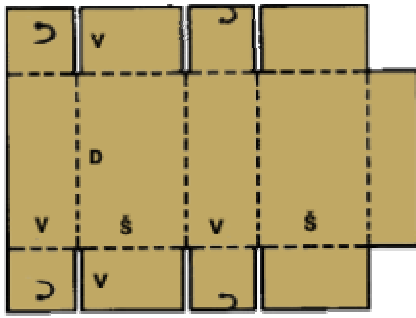

0443

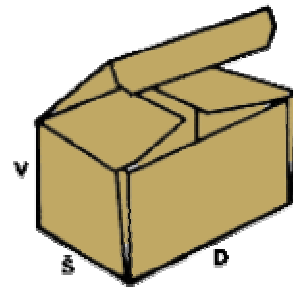
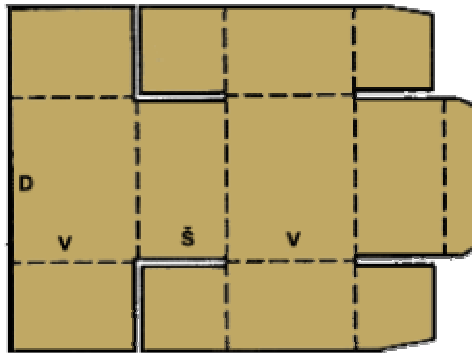

0444

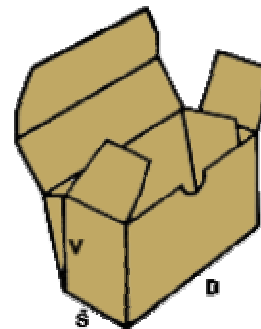
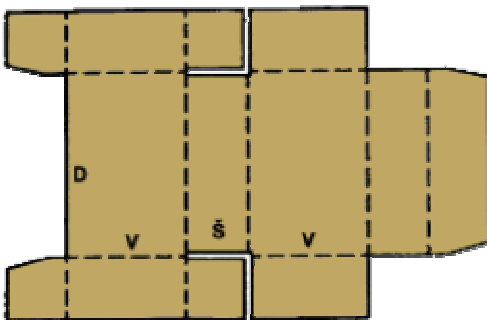

0445

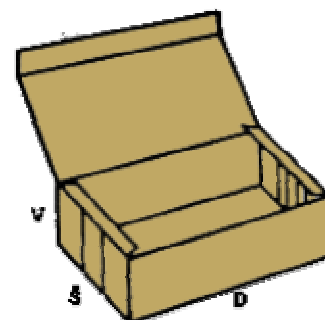
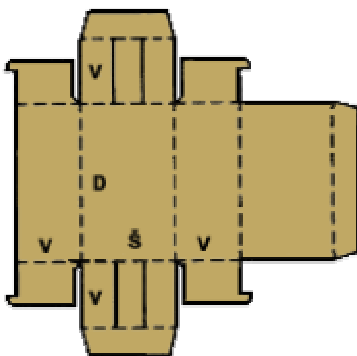

0446

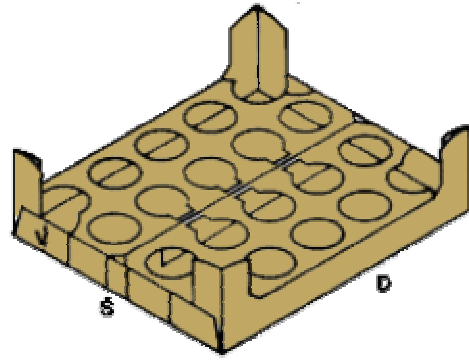
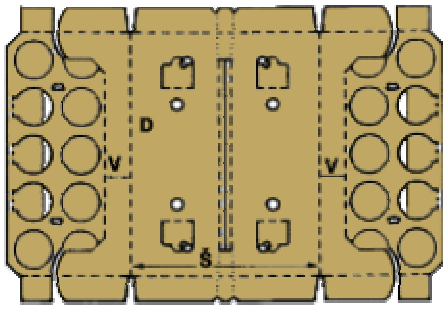

0447

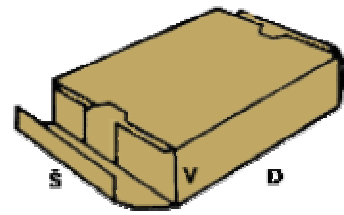
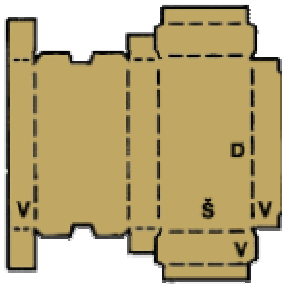

0450

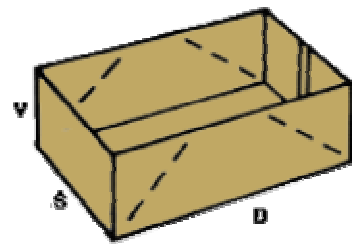
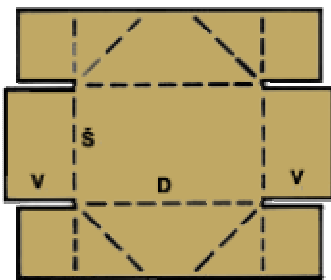

0451

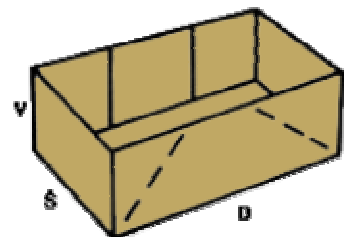
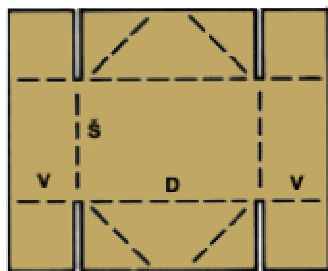

0453

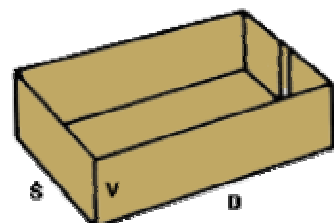
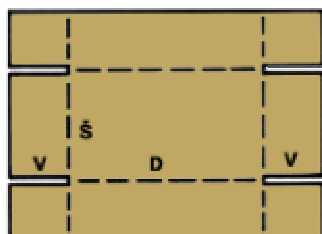

0454

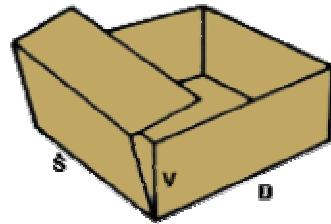
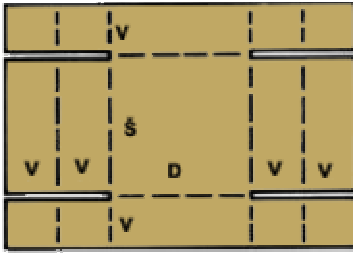

0455

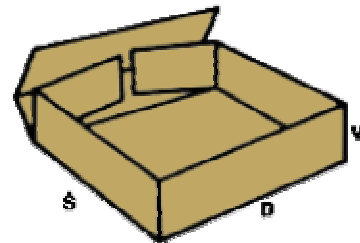
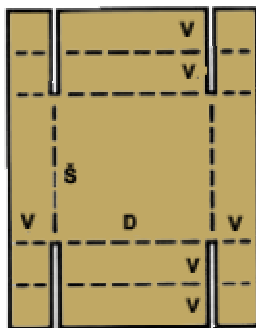

0456

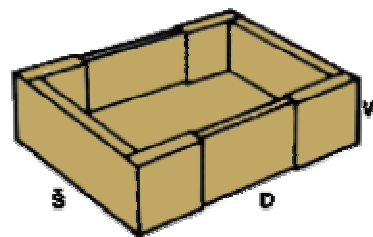
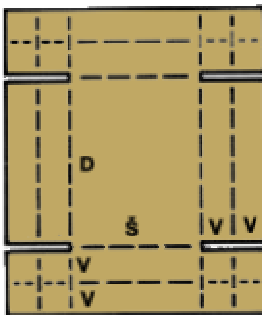

0457

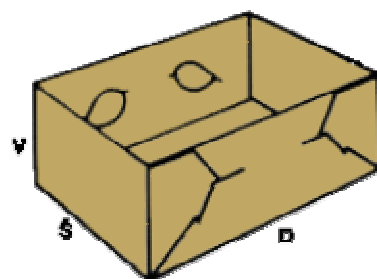
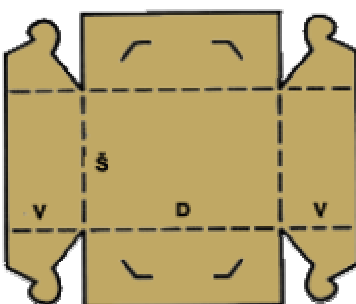

0459

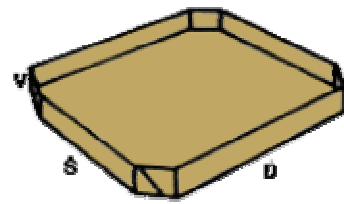
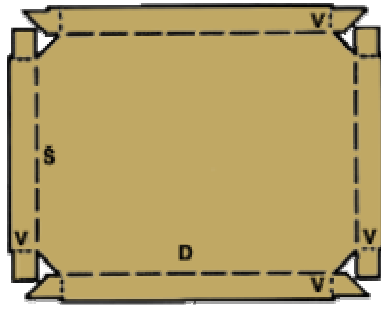

0460

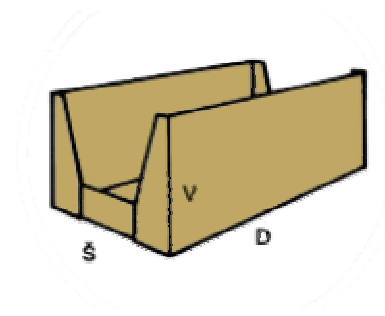
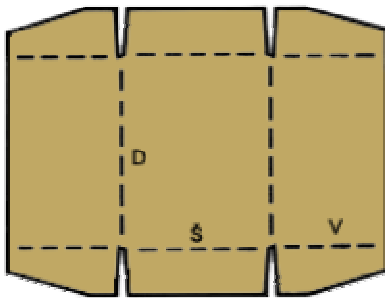

0470

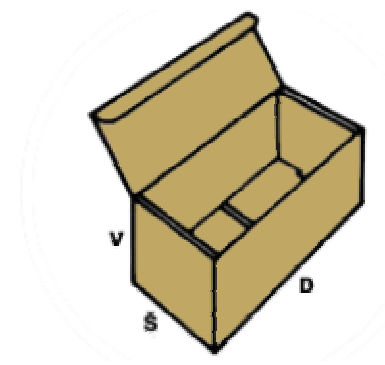
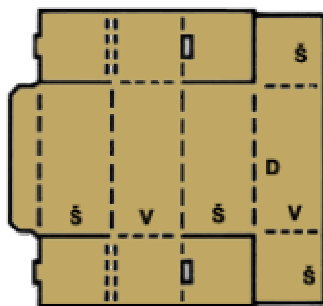

0471

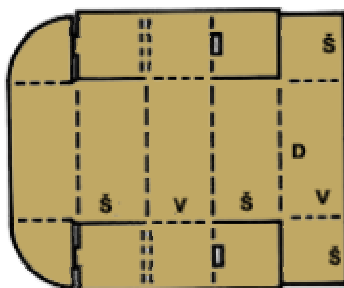

0472

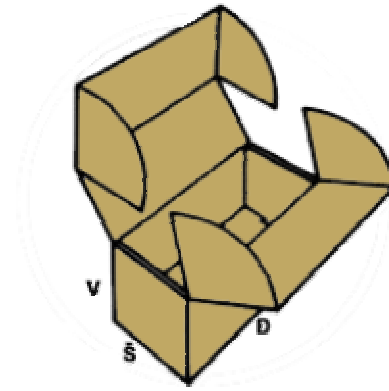
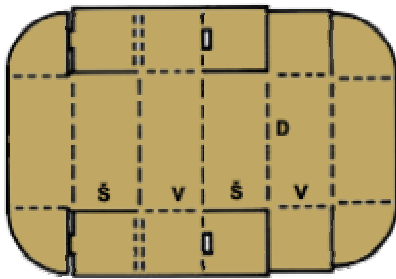

0501

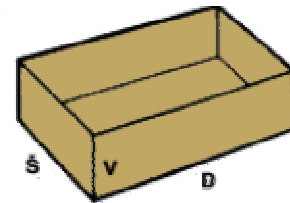

0502

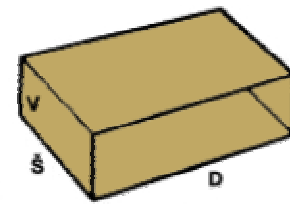
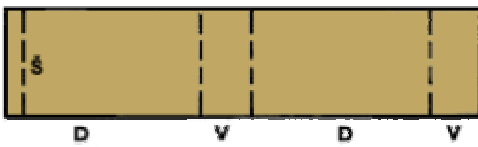

0503

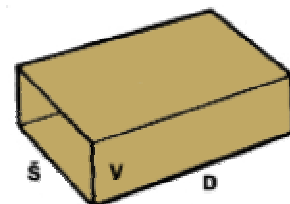
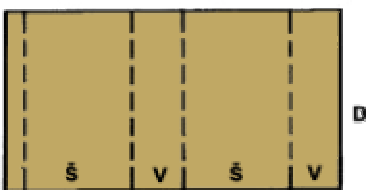

0508

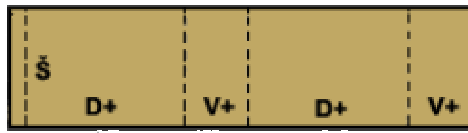

0502

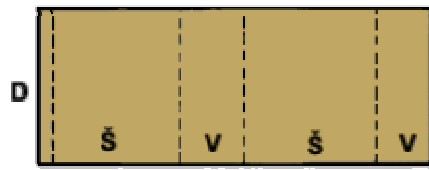

0503

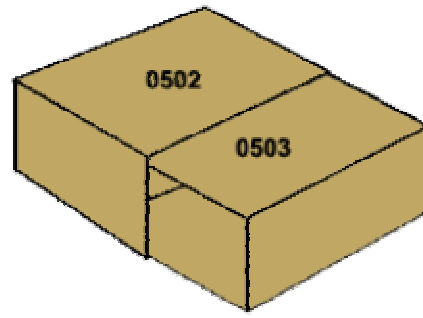

0510

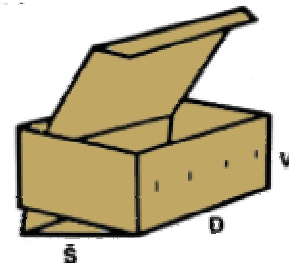
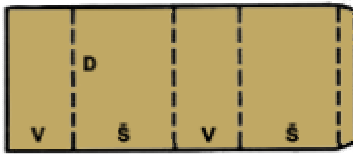

0511

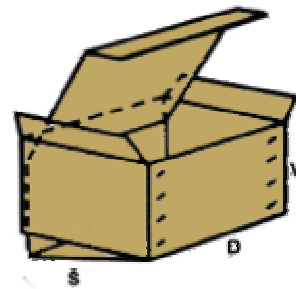
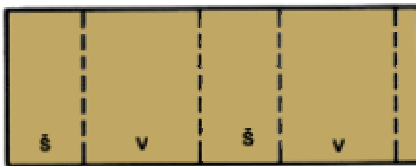

0512

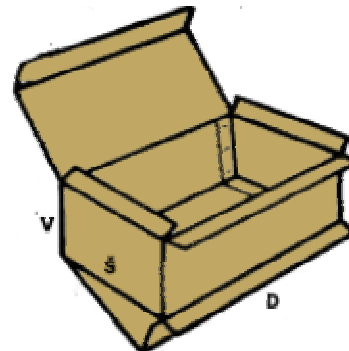
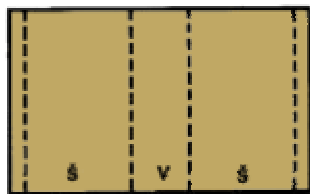

0602

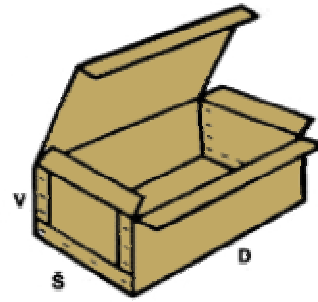
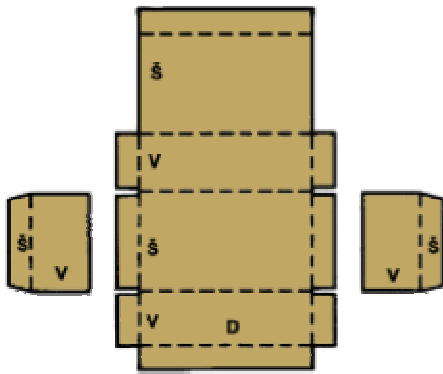

0605

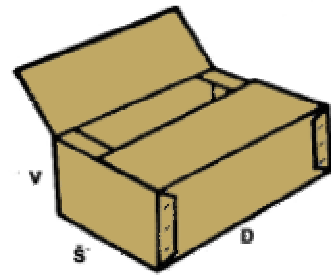
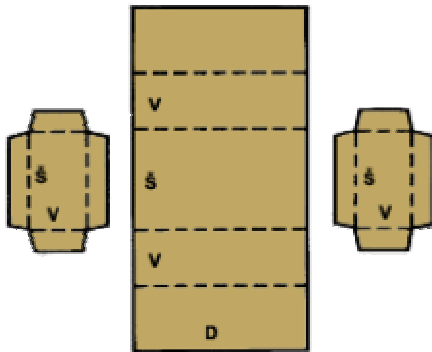

0606

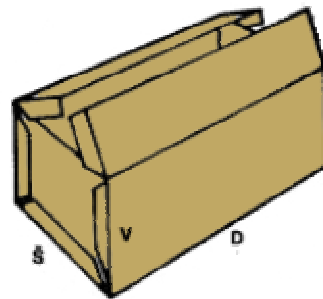
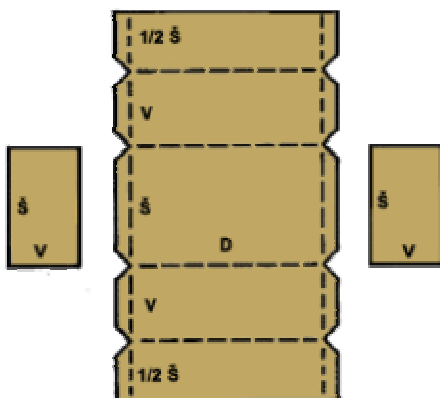

0607

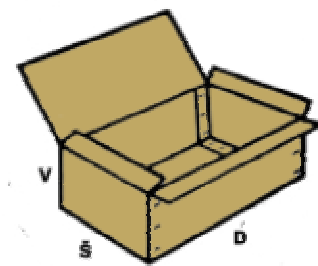
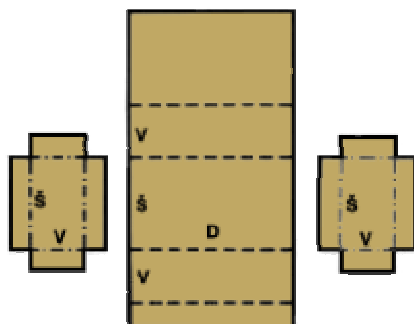

0608

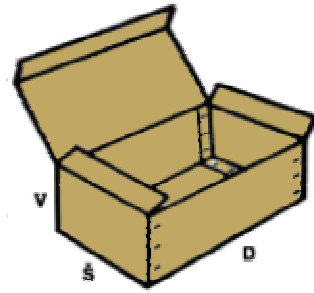
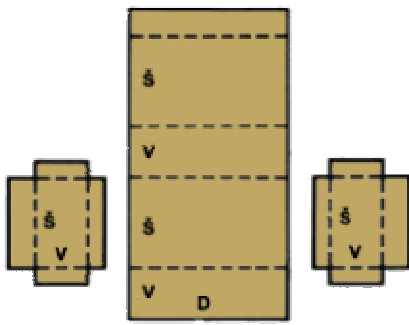

0610

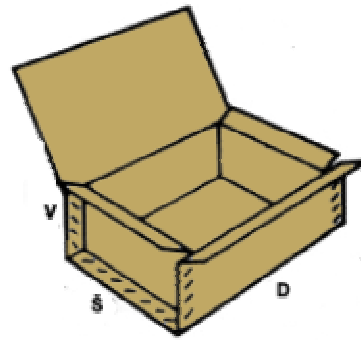
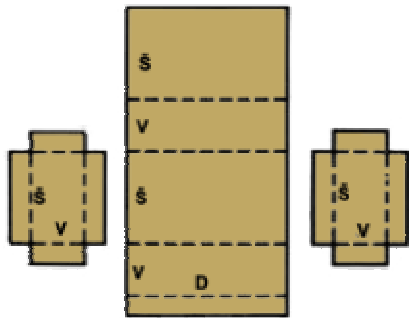

0615

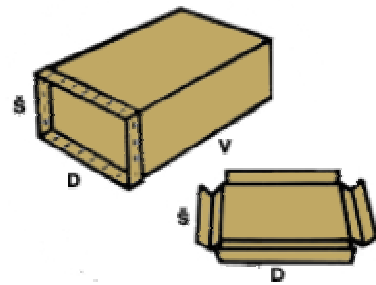
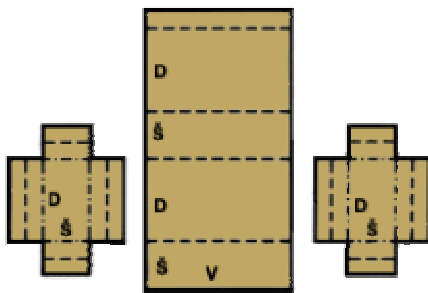

0616

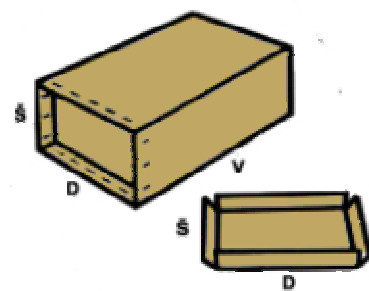
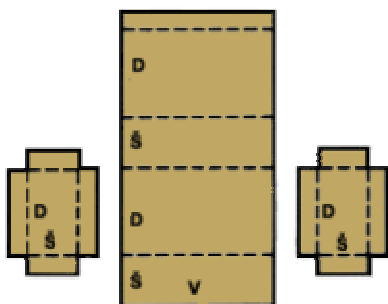

0620

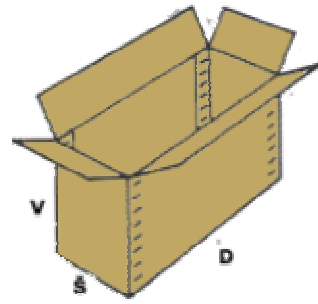
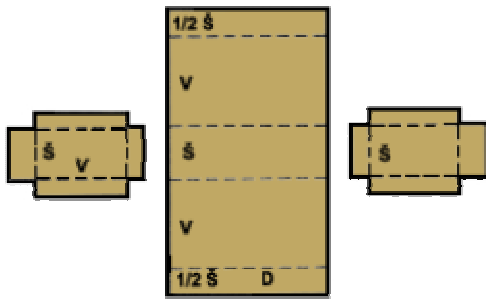

0621

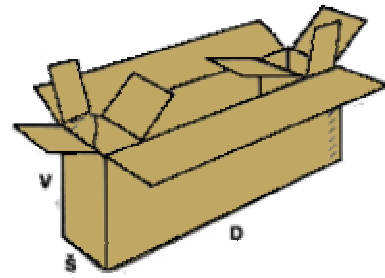
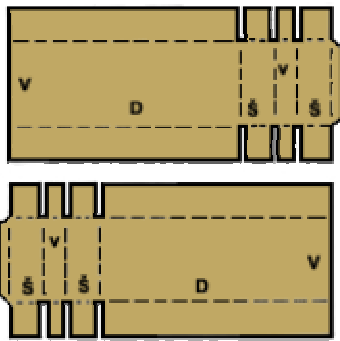

0700

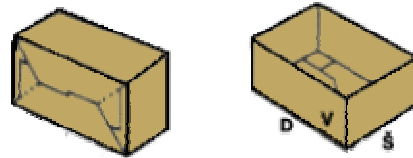
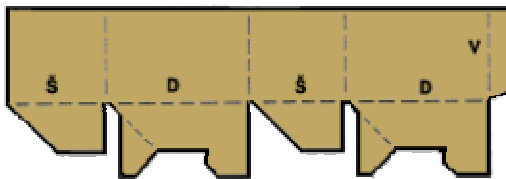

0701

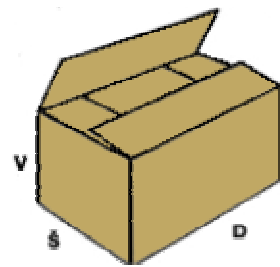
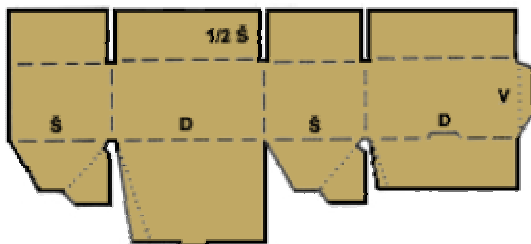

0703

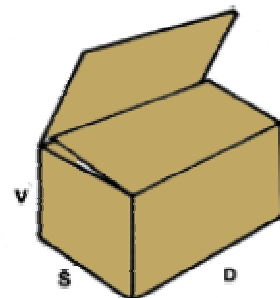
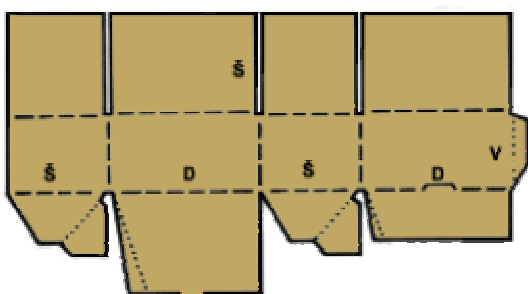

0711

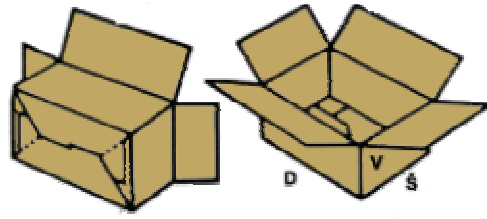
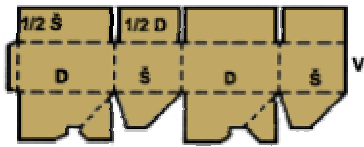

0712

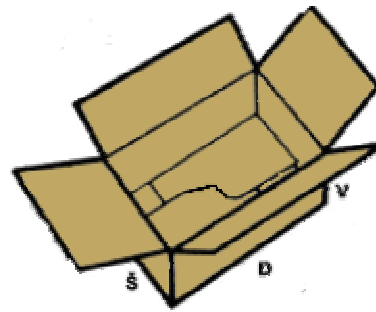
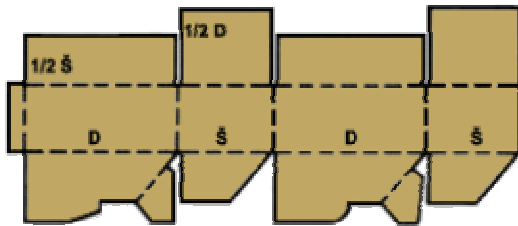

0713

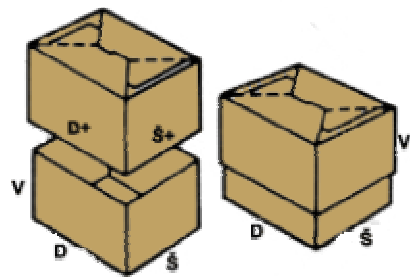
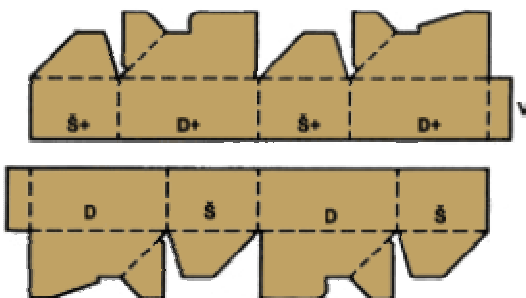
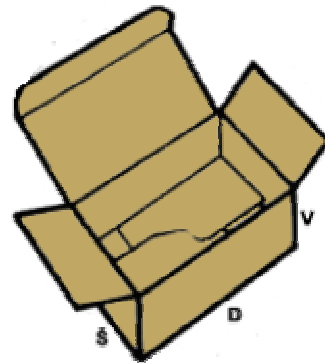
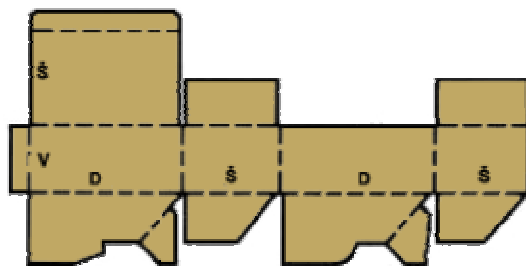

0715

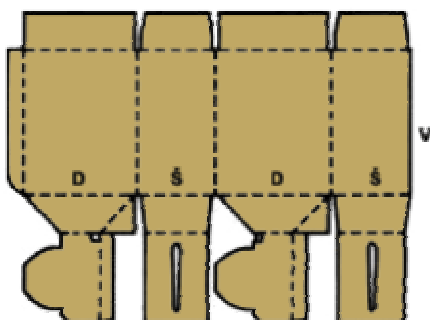

0716

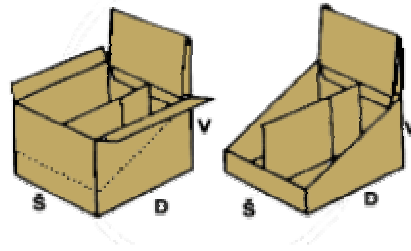
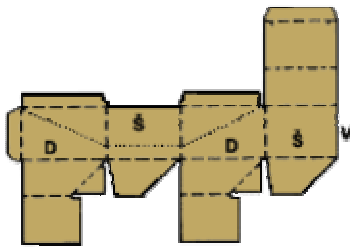

0717

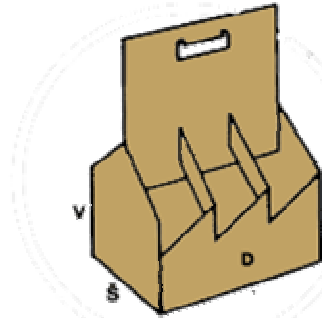
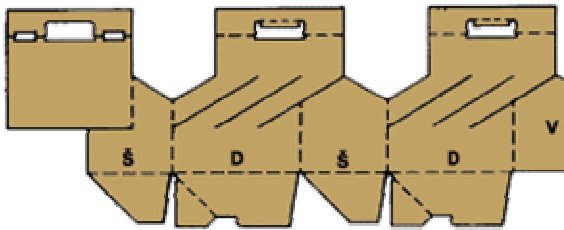

0718

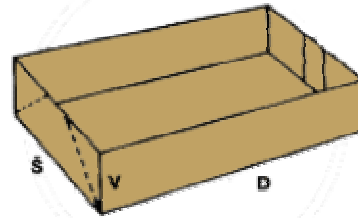
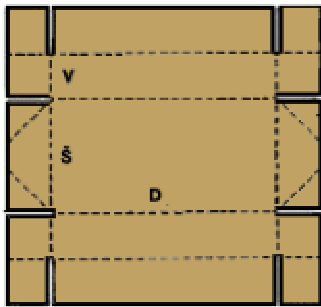

0747

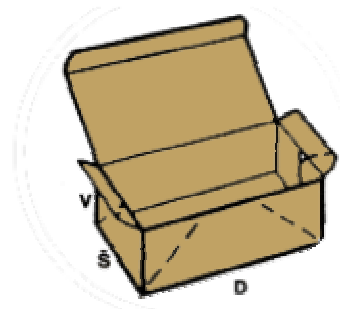
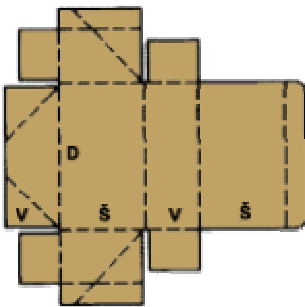

0748

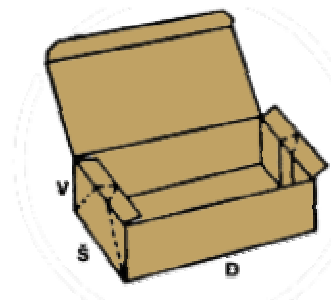
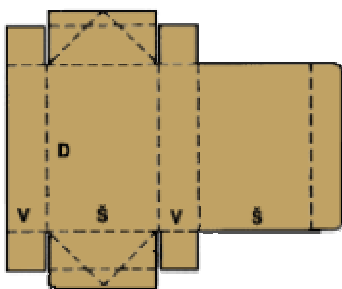

0751

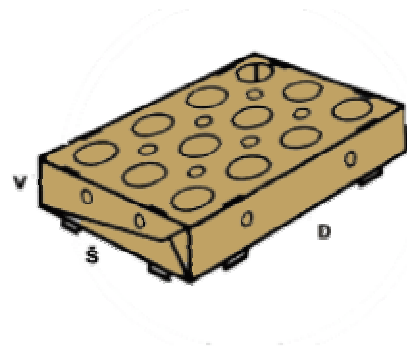
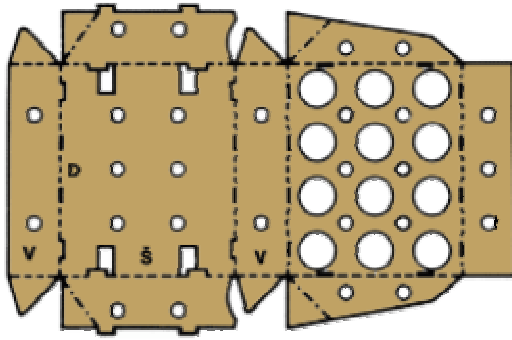

0752

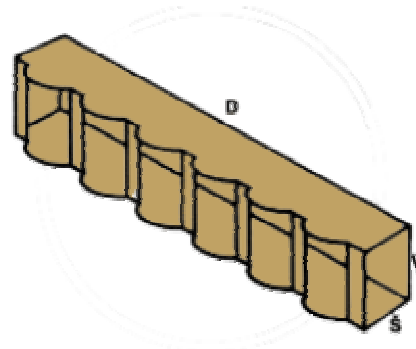
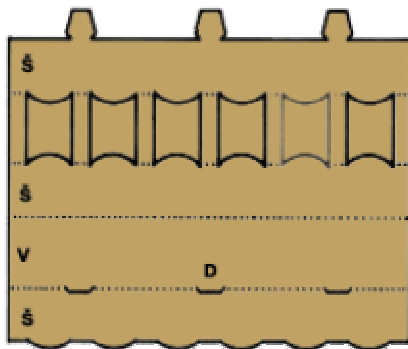

0760

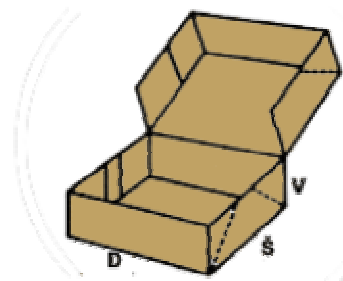
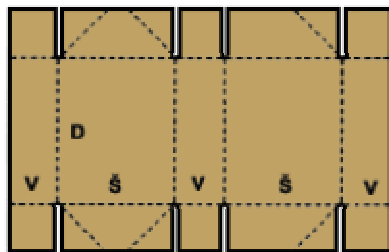

OSTATNÍ :

0900

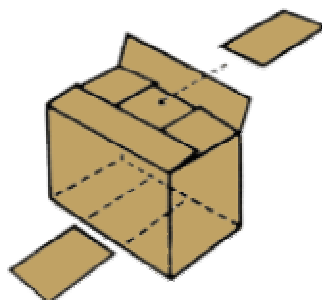

0901

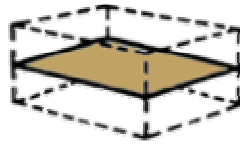

0903



0904

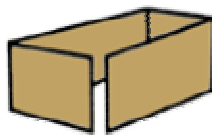

0905

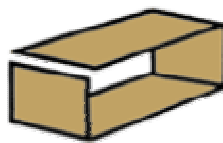

0906

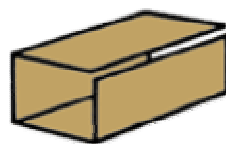

0907



0908



0909

0910

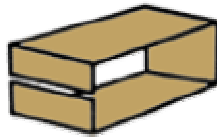

0911



0913

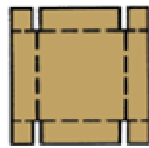

0914

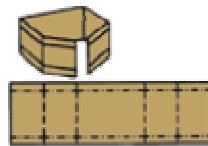

0920

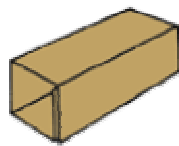

0921

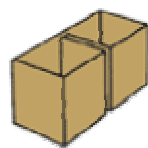

0929

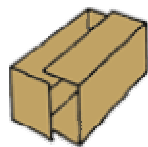

0930



0931



0932

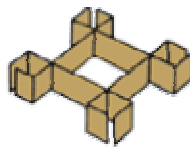

0933

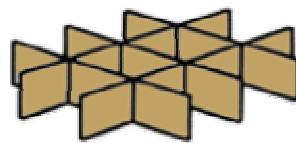

0934

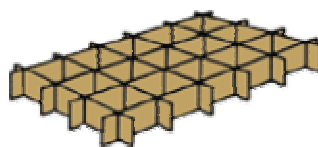

0935

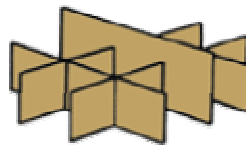

0940



0941



0942



0943



0944



0945



0946



0947



0948



0949



0950



0951



0965

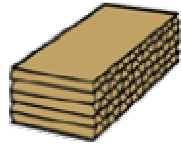

0966



0967

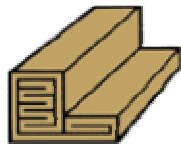

0970



0971



0972



0973



0974



0975



0976

